

Movement by Perfection



The Royal League in **ventilation**, control and drive technology



[Product documentation](#)

Type
FN040-4DK.0F.V7P1

Article number
157237

Product documentation

Customer

ZIEHL-ABEGG Contact

Project

ZIEHL-ABEGG Subsidiary
Brazil
ZIEHL-ABEGG do Brazil Imp.,
Exp. e Com. de Equipamentos
de Ventilação Ltda.
Rua Osasco, 1.295
Centro Empresarial Anhanguera
Cajamar -SP - CEP 07753-040
BRAZIL
Phone + 55 11 2898-0827
www.ziehl-abegg.com.br
info@ziehl-abegg.com.br

Type
FN040-4DK.0F.V7P1

Article number
157237



Contents

1.	Rubriküberschrift1 (CB_AF_Headline1)	Erro! Indicador não definido.
----	--------------------------------------	-------------------------------

1. Product specification

Technical data

Article number	157237
Type	FN040-4DK.0F.V7P1
Designation	Axial fan with sickle blades
Rated values	3~230/400V±10% D/Y 50Hz P ₁ 230W 0.80/ 0.46A ΔI=10% 1360/min COSY 0,73 70°C 3~230/400V±10% D/Y 60Hz P ₁ 350W 0,99/ 0,57A ΔI=10% 1500/min COSY 0,87 60°C 3~265/460V±10% D/Y 60Hz P ₁ 370W 0,97/ 0,56A ΔI=15% 1580/min COSY 0,83 60°C
Electrical connection	Terminal box K05
Min. operating temperature °C	-40
Mounting type terminal box	Mounted on Stator
Type of protection	IP54
Thermal class	THCL155
Connection diagram	1360-106XA
Rating plate	1x fixed
Fitting position	H/Vu/Vo
Motor protection	thermal contact
Impregnation	Moisture and hot climate protection
Quality of bearings	ball bearing with long-time lubrication
Material Rotor	Aluminium
Painting rotor	Rotor 1 coat painted
colour rotor	RAL 9005 (jet black)
Material blades	High Performance Composite Material
Painting impeller	unpainted
Colour blades	black
Field of application	Standardanwendung
Guard grille type	ring grill
Other	All connecting elements in stainless steel.
Painting mot.suspens	Motor suspension powder-coated consistency class 2
colour suspension	RAL 9005 (jet black)
Weight kg	5,50
ErP Data	Efficiency η_{statA} : 33,2 % Efficiency: $N_{\text{actual}} = 43,6 / N_{\text{target}} = 40^*$ *ErP 2015

2. Characteristic Curve

Air performance

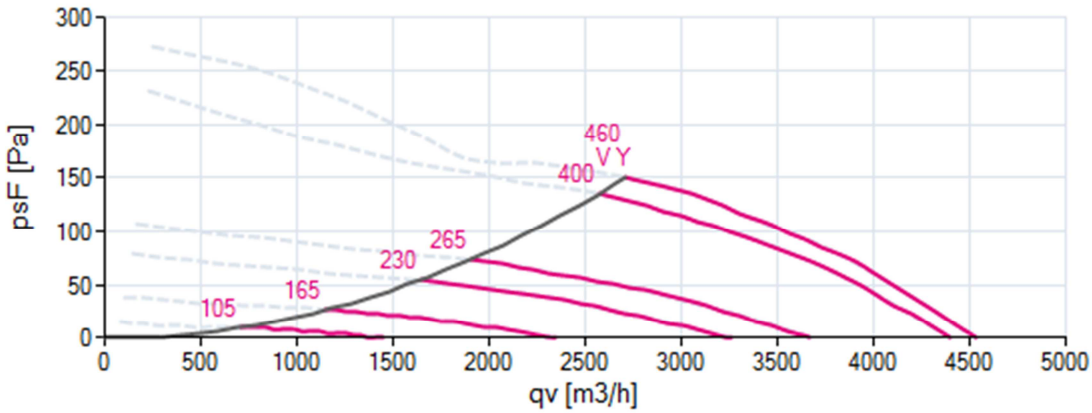

Acoustics

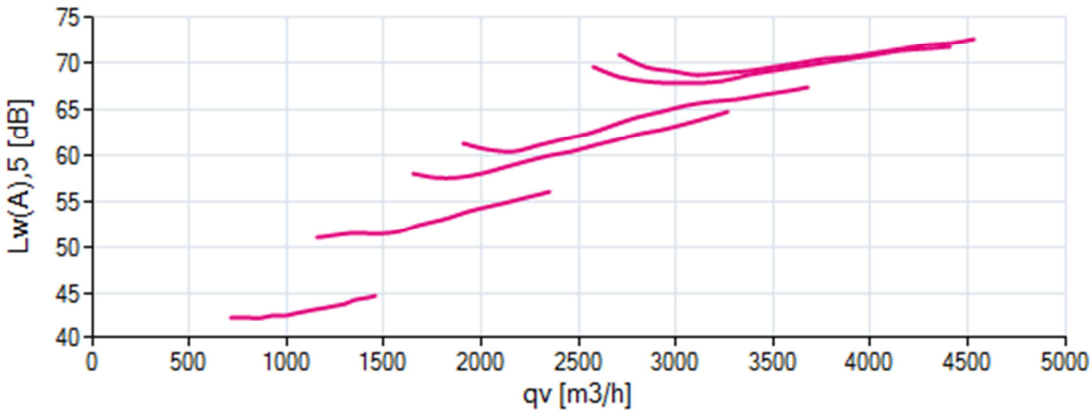

Power input

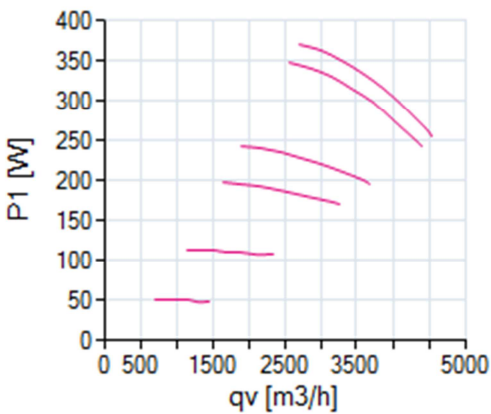

Efficiency

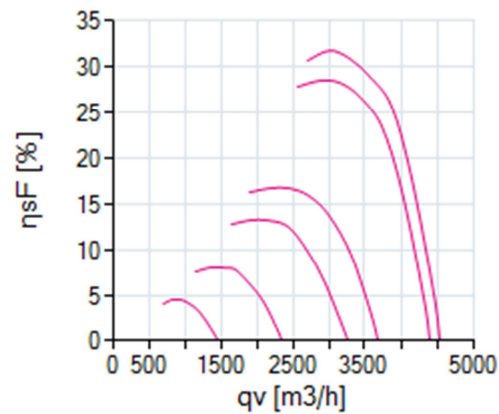

measured in full bell mouth without guard grille in installation type A according to ISO 5801

Please note: It's not allowed to use this fan in the stall area!*

*In doubt please ask your responsible ZIEHL-ABEGG sales contact.

Article number
157237

The Royal League

Die Königsklasse

Data of operating point

frequency (f_{BP})

60

mains supply

3~ 460V 60Hz Y

guard grille

no

3. Drawing

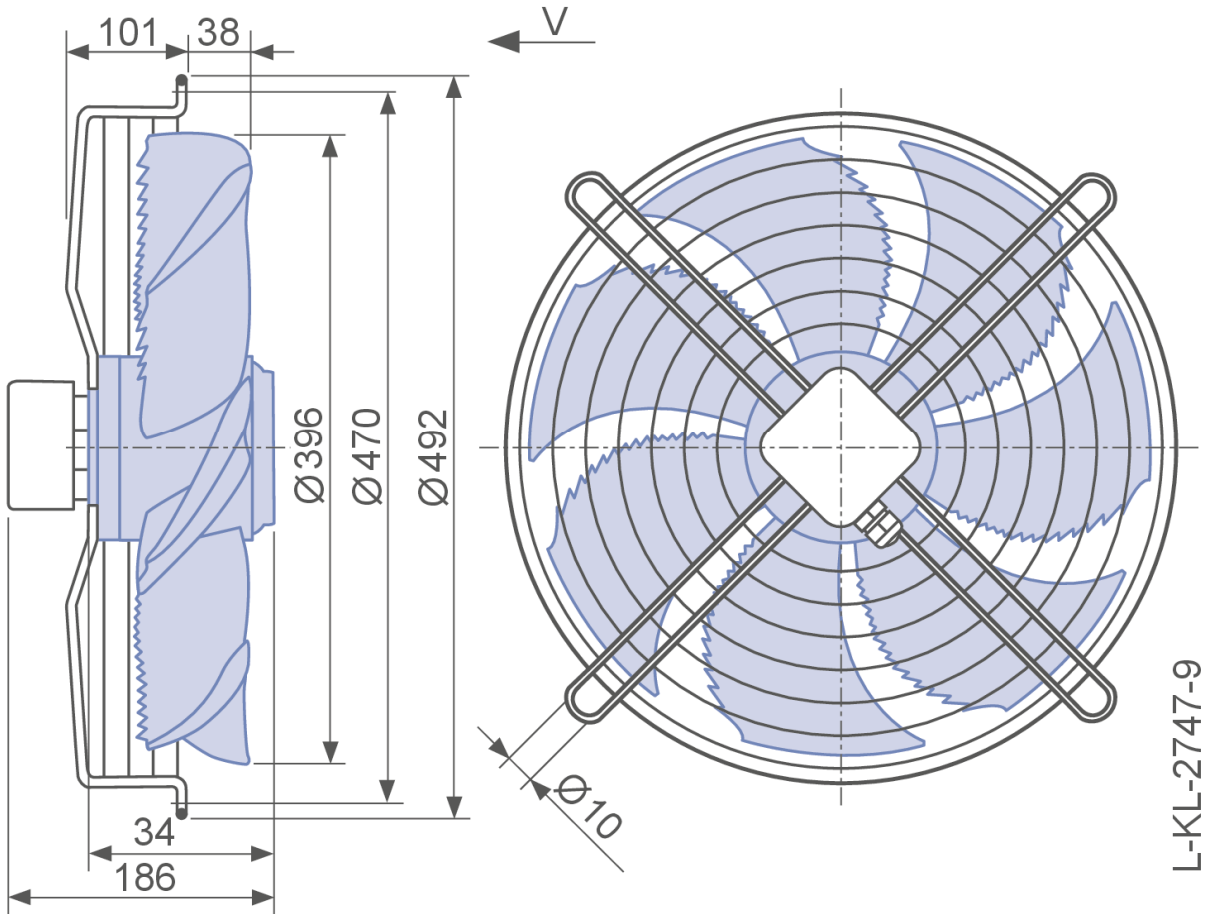

Dimensions in mm

Shown drawing is just to show the dimensions of the fan.

4. Connection diagram

1360-106XA

3~ motor with one speed and thermostatic switch (if built in).

- U1 brown
- V1 blue
- W1 black
- U2 red
- V2 grey
- W2 orange
- TB white

Δ-connection

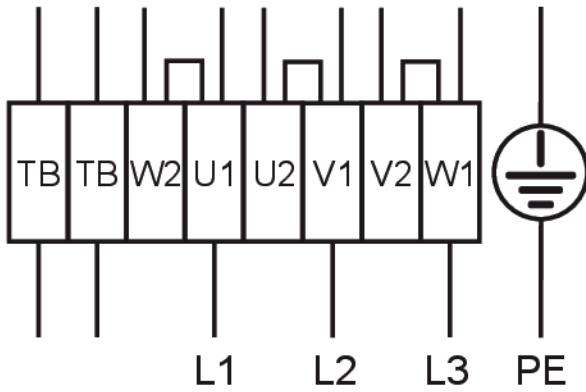

Y-connection

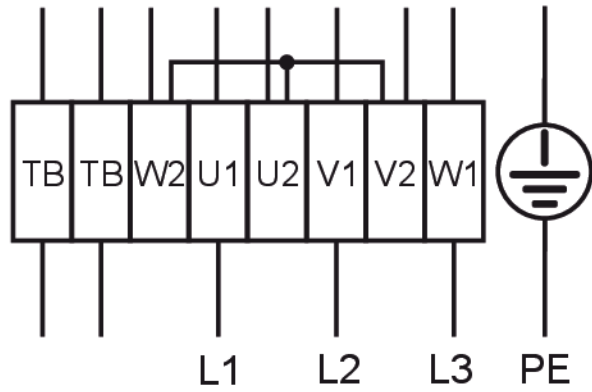

5. EU-Declaration of conformity

EC-Declaration of conformity

- Translation -
(english)
ZA75-GB 1616 Index 011
00285644-GB

Manufacturer: ZIEHL-ABEGG SE
Heinz-Ziehl-Straße
74653 Künzelsau
Germany

The manufacturer is solely responsible for issuance of the declaration of conformity.

The products:

- External rotor motor MK..., MW..
- Axial fan FA..., FB..., FC..., FE..., FF..., FS..., FT..., FH..., FL..., FN..., FV..., DN..., VR..., VN..., ZC..., ZF..., ZN..
- Centrifugal fan RA..., RD..., RE..., RF..., RG..., RH..., RK..., RM..., RR..., RZ..., GR..., ER..
- Cross-flow fan QK..., QR..., QT..., QG..

The engine type:

- Asynchronous internal or external rotor motor
- Asynchronous internal or external rotor motor with integrated frequency inverter, except EDP system
- Electronically commutated (EC) internal or external rotor motor
- Electronically commutated internal or external rotor motor with integrated EC Controller, except EDP system

These products comply with the following EU directives:

- EMC Directive 2014/30/EU
- Low voltage directive 2014/35/EU
- ErP Directive 2009/125/EC, in conjunction with Regulation (EU) no. 327/2011

The following harmonized standards are in use:

EN 60034-1:2010 + Cor.:2010 EN 61000-6-3:2007 + A1:2011 + AC:2012
EN 60204-1:2006 + A1:2009 + AC:2010 EN 61000-6-2:2005 + AC:2005
EN 60529:1991 + A1:2000 + A2:2013

Compliance with the ErP Directive 2009/125/EC does not refer to external rotor motors MK..., MW..

All ErP-relevant information comprises measurements which are determined using a standardised measurement set-up. More details can be obtained from the manufacturer.

Compliance with the EMC Directive 2014/30 / EU refers only to those products when they are connected by mounting / operating instructions . If these products are integrated into a system or supplemented with other components (eg. sensing controls) and operated , the manufacturer or operator is responsible of the overall system for compliance with the EMC Directive 2014/30 / EU .

Künzelsau, 20.04.2016
(Location, date of issue)

ZIEHL-ABEGG SE
Dr. W. Angelis
Technical Director Air Movement Division
(Name, Function)

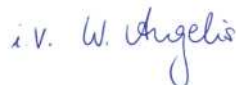

(Signature)





The Royal League in ventilation, control and drive technology

Intelligent control technology for any application

ZIEHL-ABEGG system capabilities:
Everything from a single source – perfectly matched for optimal performance

Please contact us. We would be pleased to design an individual solution for your requirements.

We would like to welcome you on our worldwide exhibitions. Please find our next exhibitions [here](#).